

5

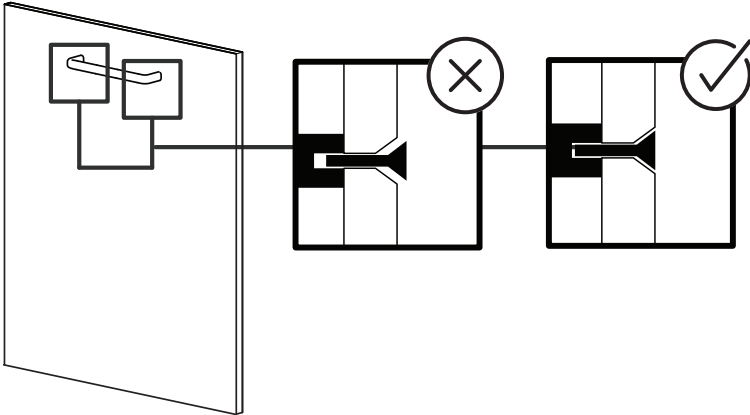

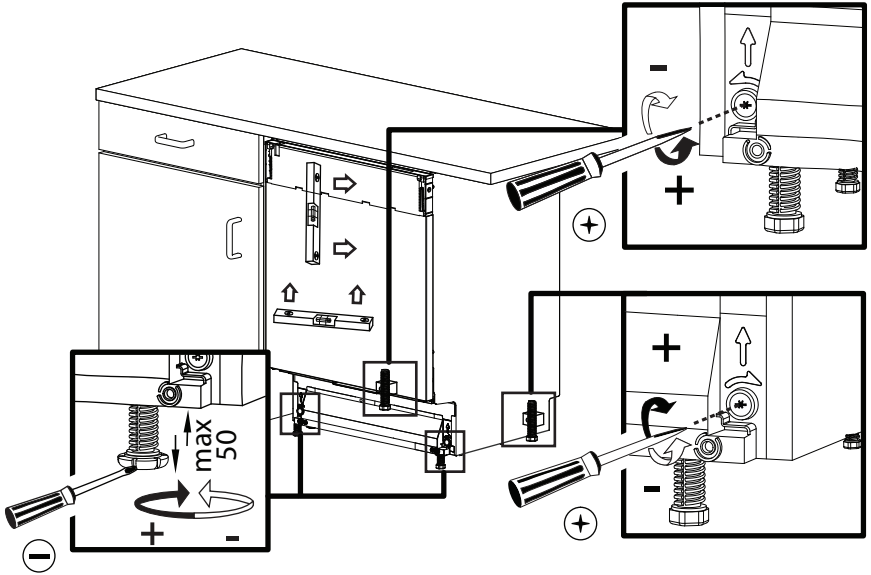

7

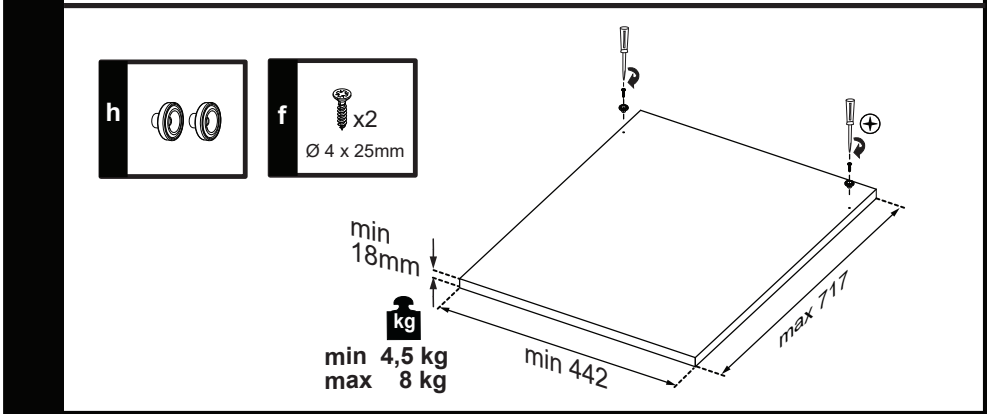
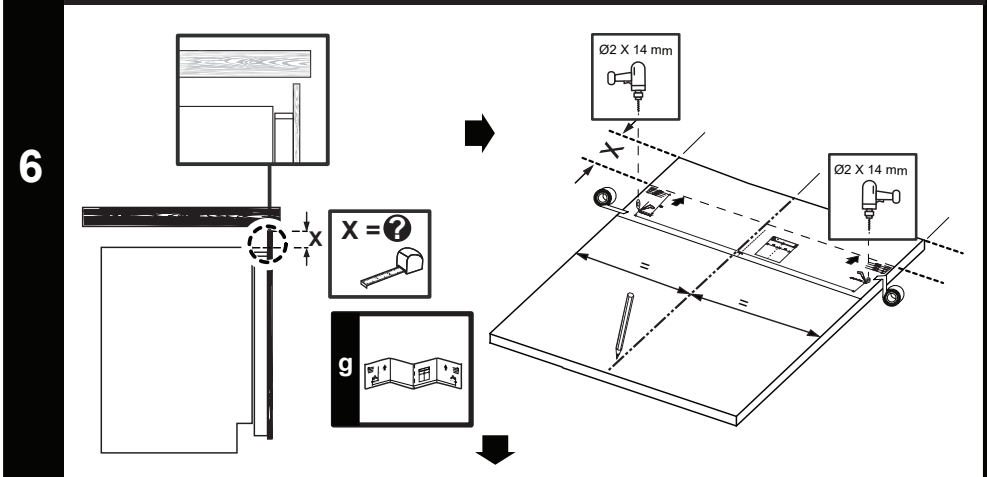
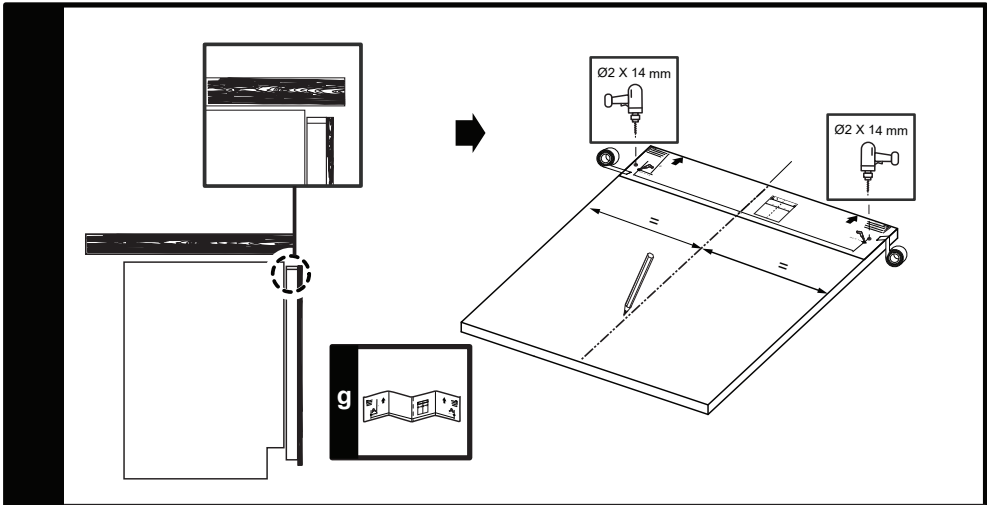
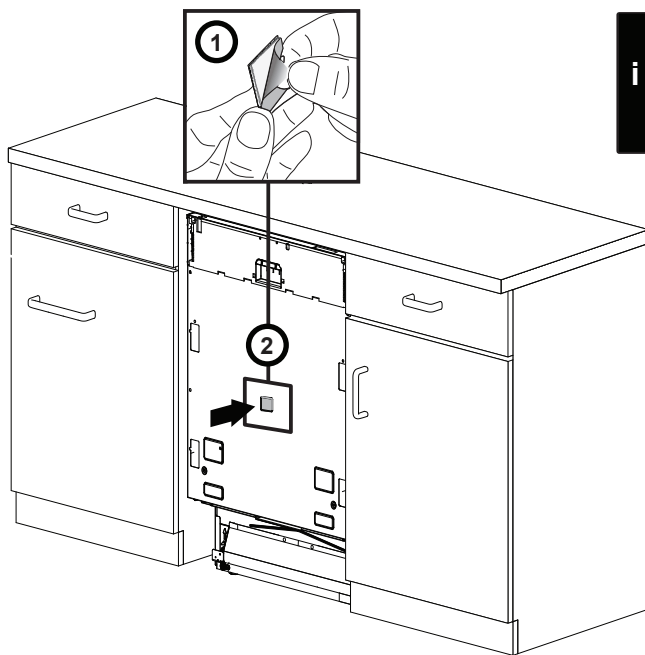

8

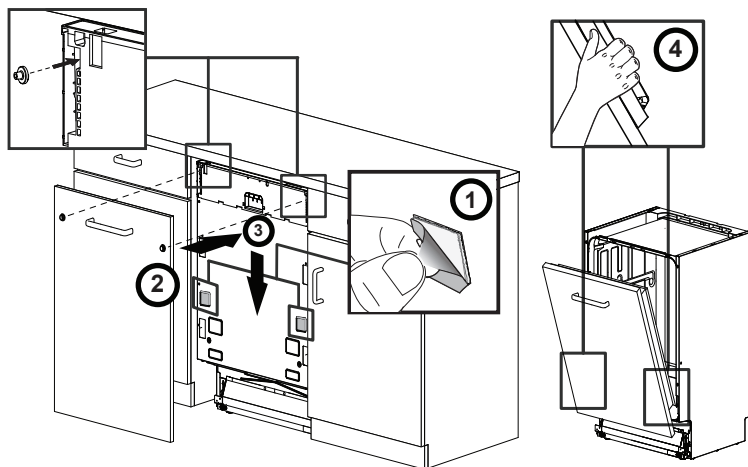

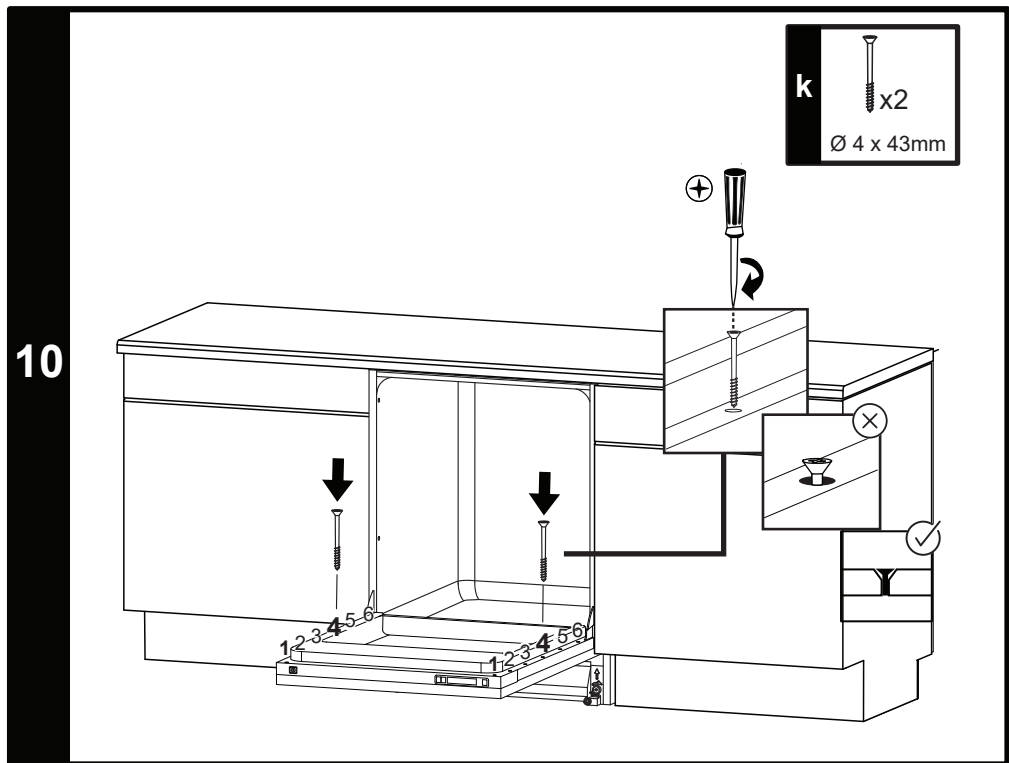
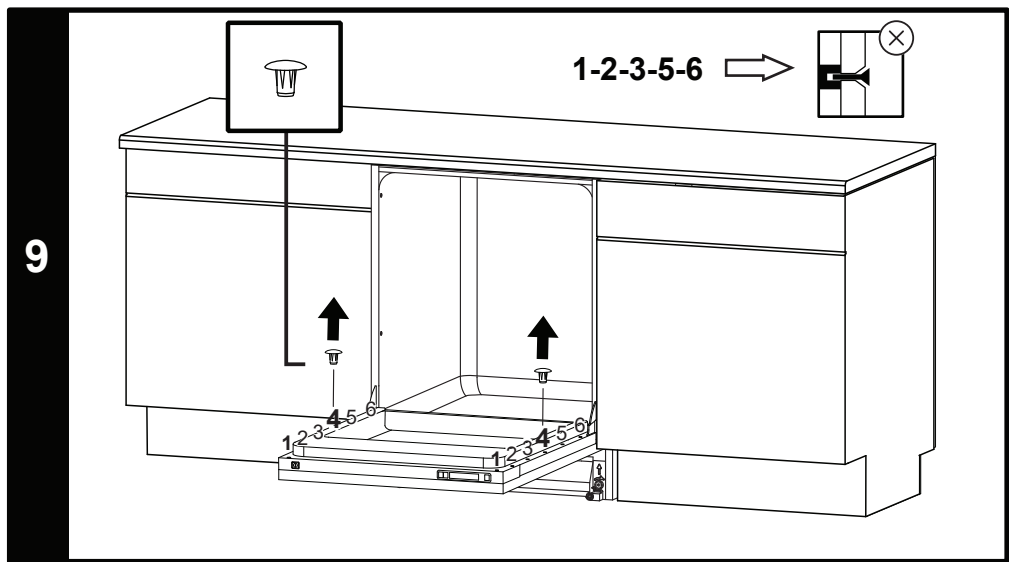

⚠
11
⚠

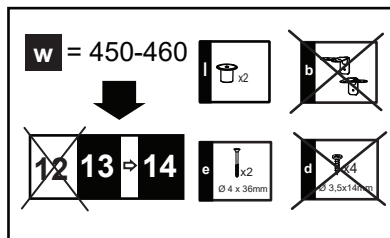
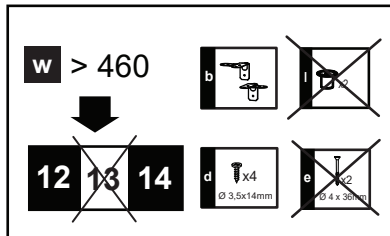
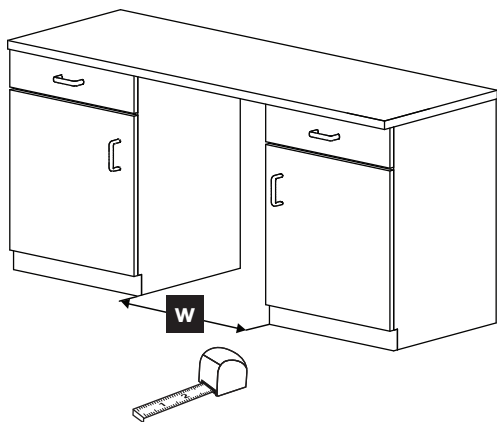

12
—
a

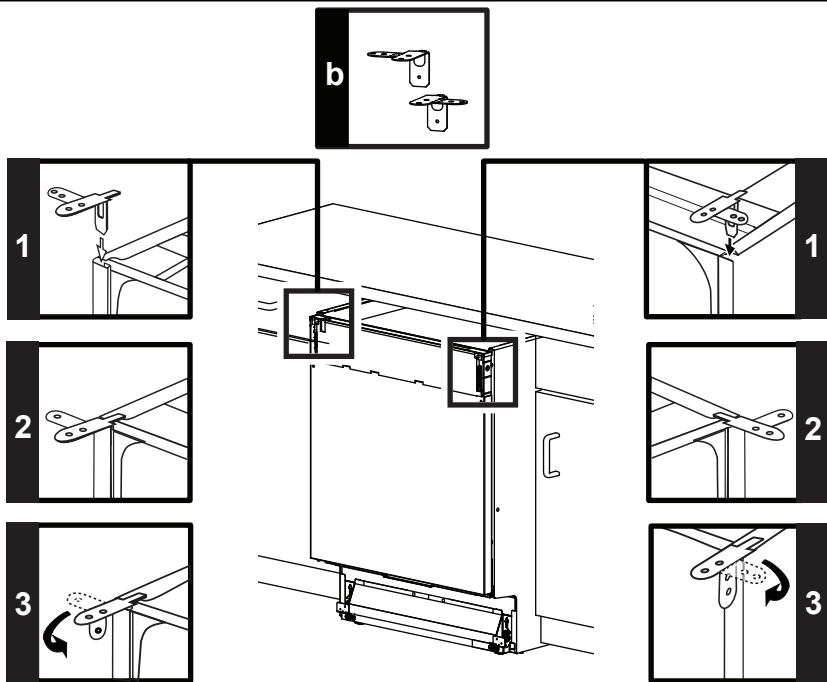

12
-
b

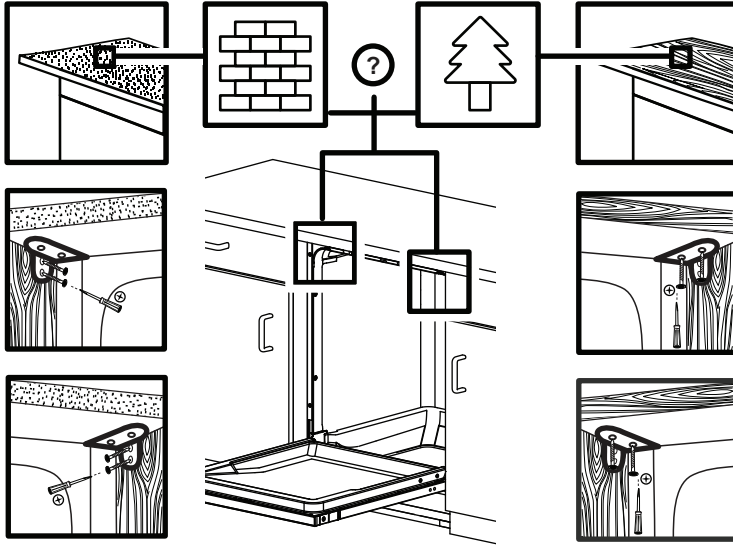

d
x4
Ø 3,5x14mm

13
-
a

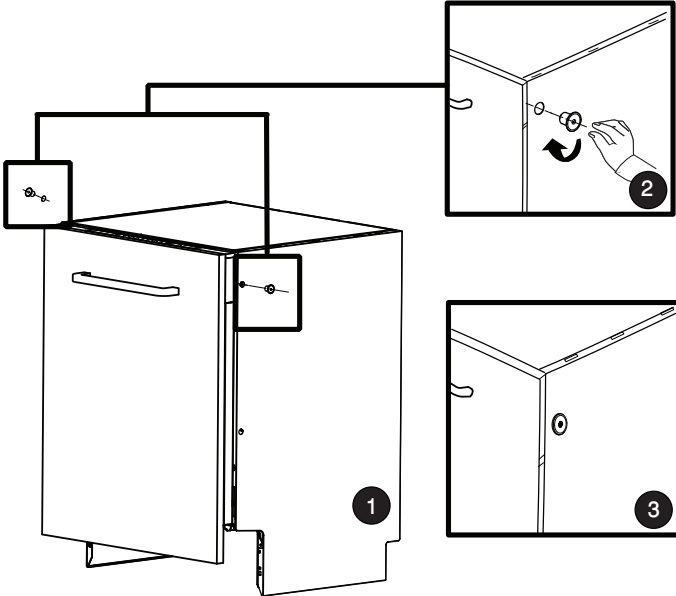

x2

13
b

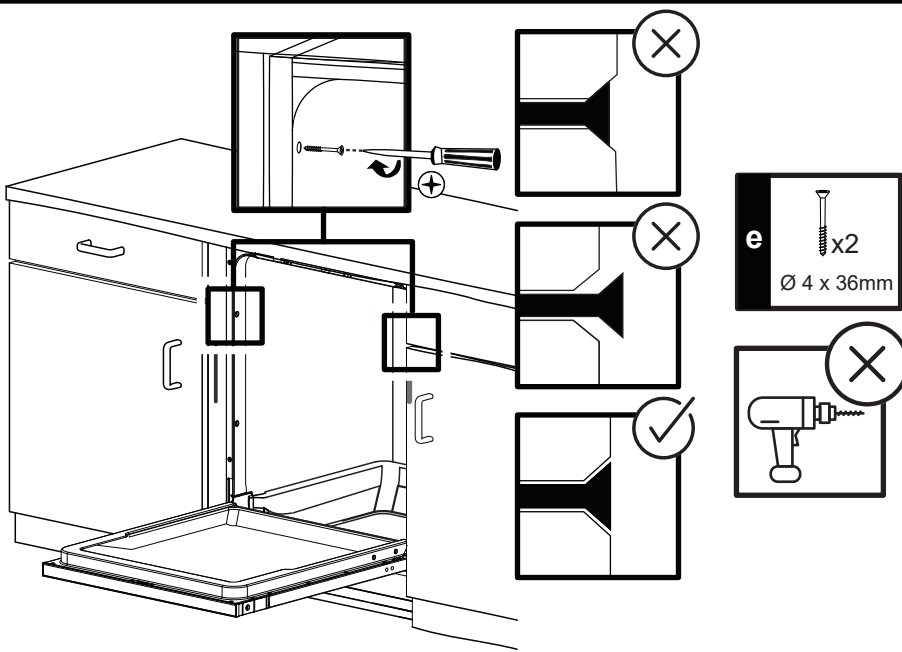

14

